

Mechanical Specifications

Standard Construction

- Volute : 316L Stainless Steel (Forged Stamping)
- Impeller : 316 Stainless Steel
- Backplate : 316L Stainless Steel
- Stub Shaft : 316L Stainless Steel
- Adapter : 304 Stainless Steel
- Optional leg kit : 304 Stainless Steel
- Seal type : " D " and " DG " with clamped in seat
- Rotary seal material : Carbon, Silicon carbide rotating element available as option
- " DG " seal seat material : Silicon carbide, Ceramic and Tungsten carbide
- Elastomers FDA: Buna, EPDM, Silicone and FKM
- Surface finish : Sanitary polish 32R

C-Series Sanitary Centrifugal Pump

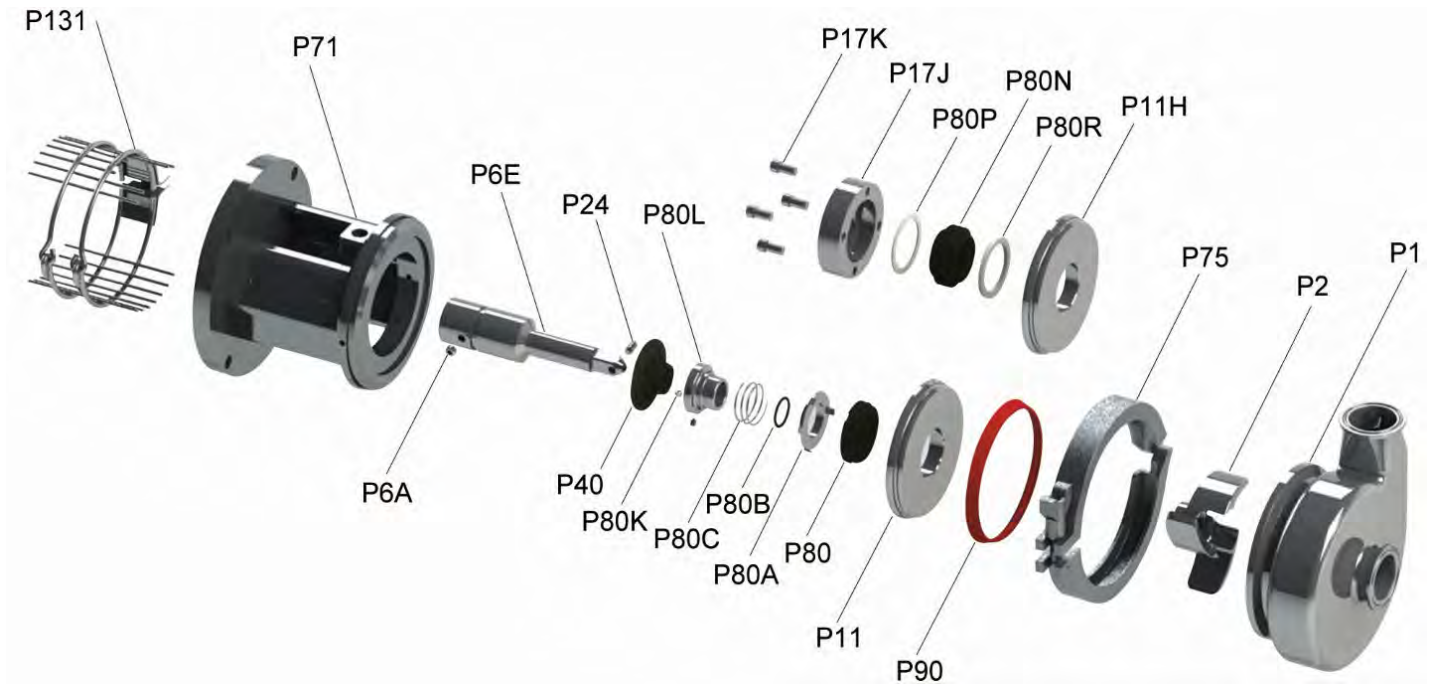

Material list

Key No.	Description	Material
P1	Casing	316L
P2	Impeller	316(CF8M)
P75	Clamp	304
P90	Casing gasket	BUNA / EPDM / Silicone / Viton
P11	Back plate (D seal)	316L
P11F	Back plate pin	304
P11H	Back plate (DG seal)	316L
P17J	Gland ring (DG seal)	304
P17K	Gland bolt (DG seal)	304
P17M	Washers (DG seal)	304
P80	Rotary seal	Carbon / Silicone carbon
P80A	Seal cup	304
P80B	Seal O-ring	BUNA / EPDM / Silicone / Viton
P80C	Spring	304
P80K	Seat screw	304
P80L	Drive collar	304
P80N	Seal seat (DG seal)	Silicone carbide / Ceramic / Tungsten carbide
P80P	Outboard gasket (DG seal)	PTFE
P80R	Inboard gasket (DG seal)	PTFE
P6E	Stub shaft	316L
P6A	Stub shaft set screw	316L
P40	Deflector	EPDM
P71	Adapter	304
P71A	Adapter pin	304
P131	Guard assembly	304
P207	Adjustable leg kit	304

C-Series Sanitary Centrifugal Pump

Dimensions

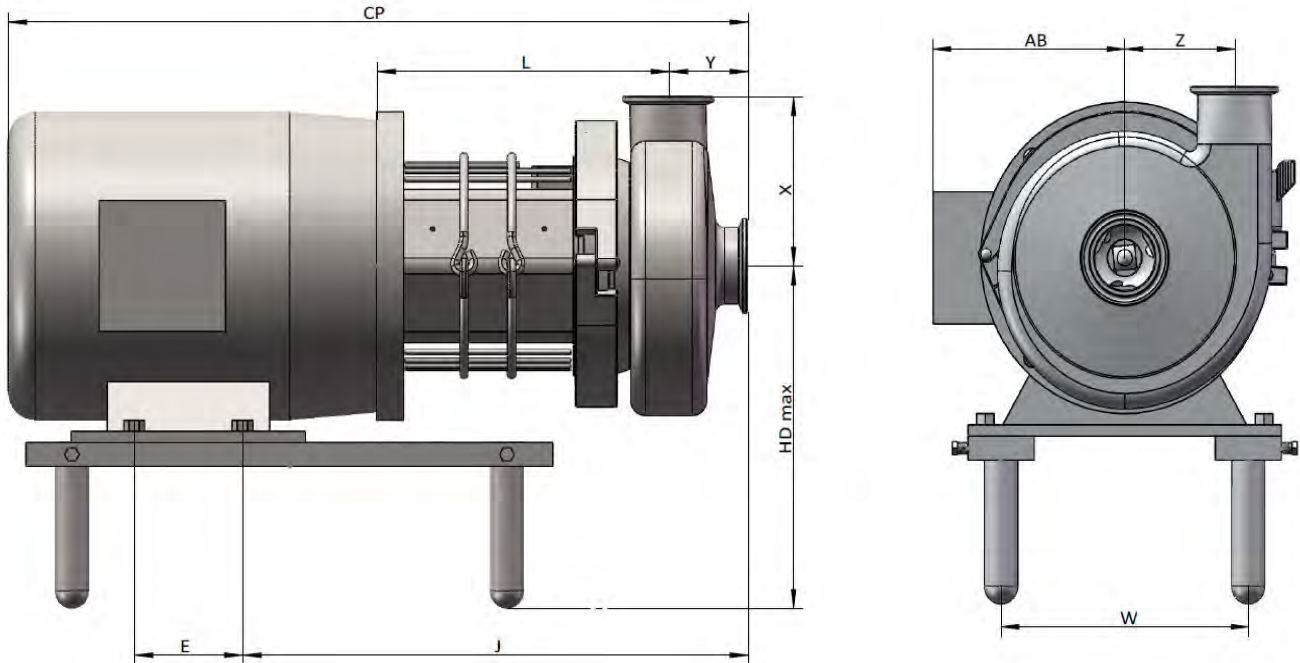

Pump Model	Frame Size	X	Y	CP	E	HD Max	J	L
C 114	56C	3.63	1.63	18.00	3.00	7.00	10.60	6.22
	140TC	3.63	1.63	18.20	4.00	7.00	10.80	6.22
	180TC	3.63	1.63	18.80	4.50	8.00	11.00	6.78
C 216	56C	4.50	1.94	16.26	3.00	7.00	8.81	6.06
	140TC	4.50	1.94	18.70	4.00	7.00	11.25	6.06
	180TC	4.50	1.94	22.00	4.50	8.00	12.00	6.69
	210TC	4.50	1.94	25.70	5.50	8.75	13.90	7.81
	250TC	4.50	1.94	31.40	10.00	9.75	15.70	8.50
C 218 & C 328	140TC	5.50	1.94 / 2.25	18.50	4.00	7.00	11.10	6.31
	180TC	5.50	1.94 / 2.25	22.50	4.50	8.00	12.00	6.94
	210TC	5.50	1.94 / 2.25	26.30	5.50	8.75	14.50	7.31
	250TC	5.50	1.94 / 2.25	31.20	10.00	9.75	15.50	8.19
	280TC	5.50	1.94 / 2.25	33.80	11.00	10.50	15.60	8.81
	320TC	5.50	1.94 / 2.25	36.70	12.00	11.50	17.90	9.69

Pump Model	Inlet	Outlet	Z	Frame Size	AB	Conduit Entry diameter	W
C 114	1.5	1.5	2.63	56C	5.53	0.87	4.85
C 214	2			140TC	5.53	0.87	5.50
C 216	2	1.5	3.69	180TC	7.00	0.87	7.50
C 516	2.5			210TC	7.62	0.87	8.50
C 218	2	1.5	4.75	250TC	10.80	2.05	10.00
C 318	3			280TSC	13.40	2.36	11.00
C 328	3			320TSC	14.37	2.36	12.00
C 428	4	2	4.75				

All dimensions are give in inches

C Series Centrifugal Pump

Size: 1.5x1.5x4
RPM: 1750
Frequency: 60 Hz
Model #: C114

PERFORMANCE CURVES (Based on H₂O @ 70° F)

C114 @ 1750 RPM

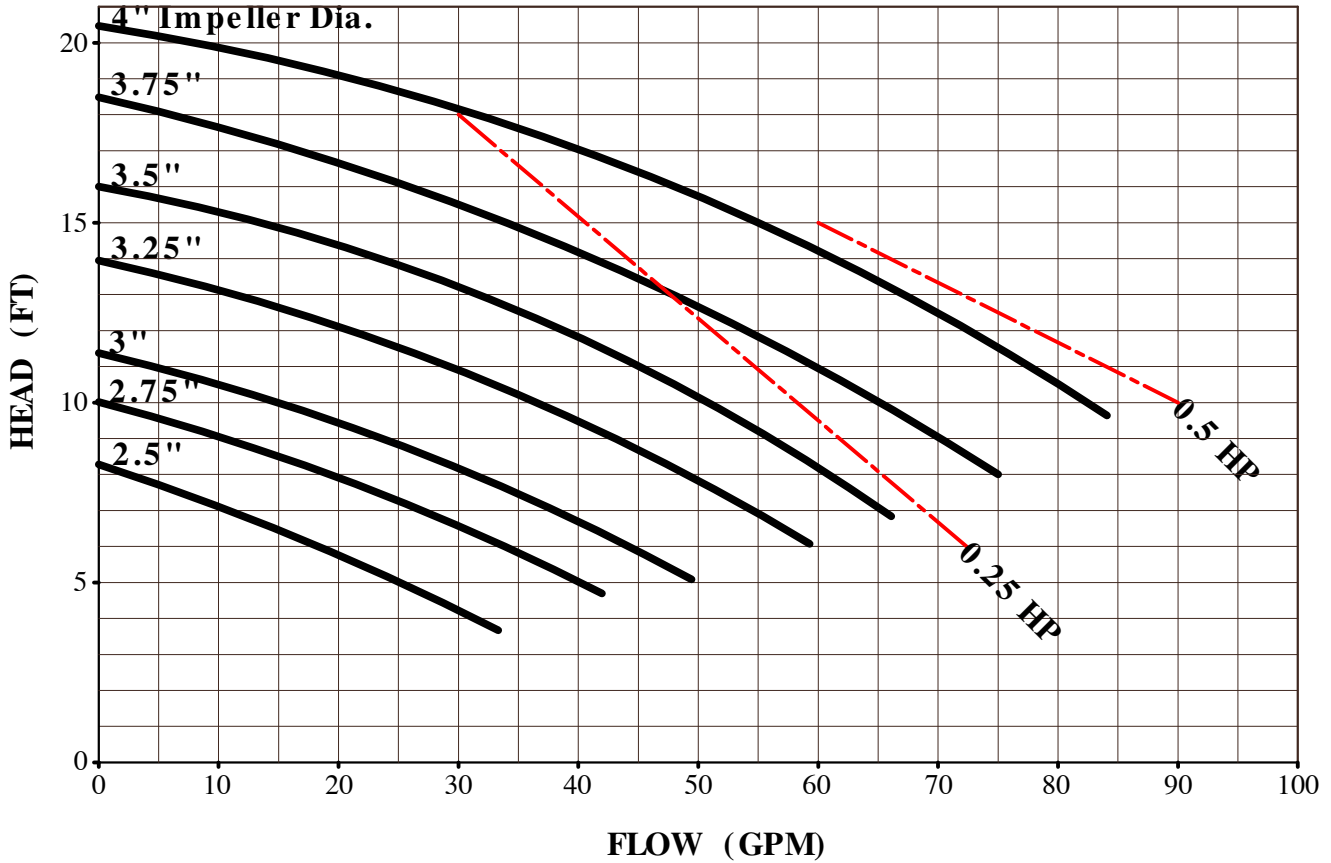

NPSHR (4" Impeller)

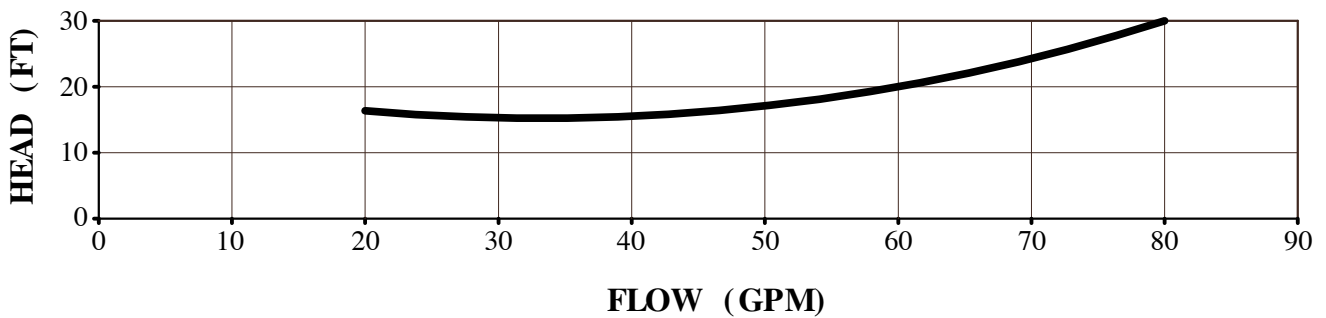

C Series Centrifugal Pump

Size: 1.5x1.5x4
RPM: 3500
Frequency: 60 Hz
Model #: C114

PERFORMANCE CURVES (Based on H₂O @ 70° F)

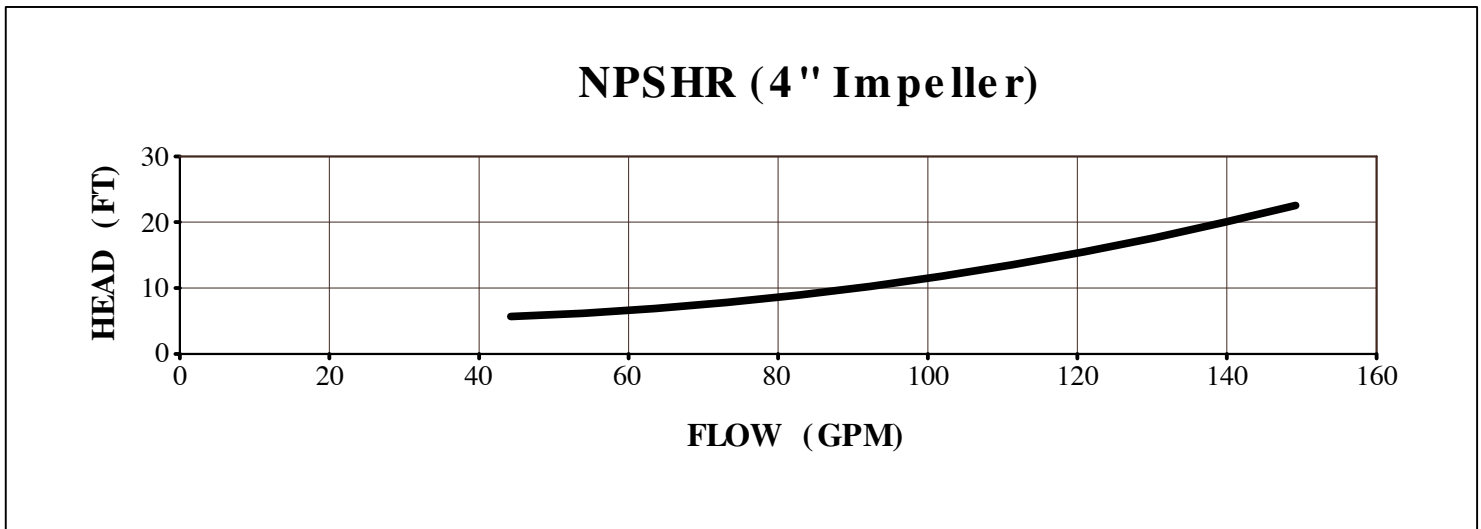
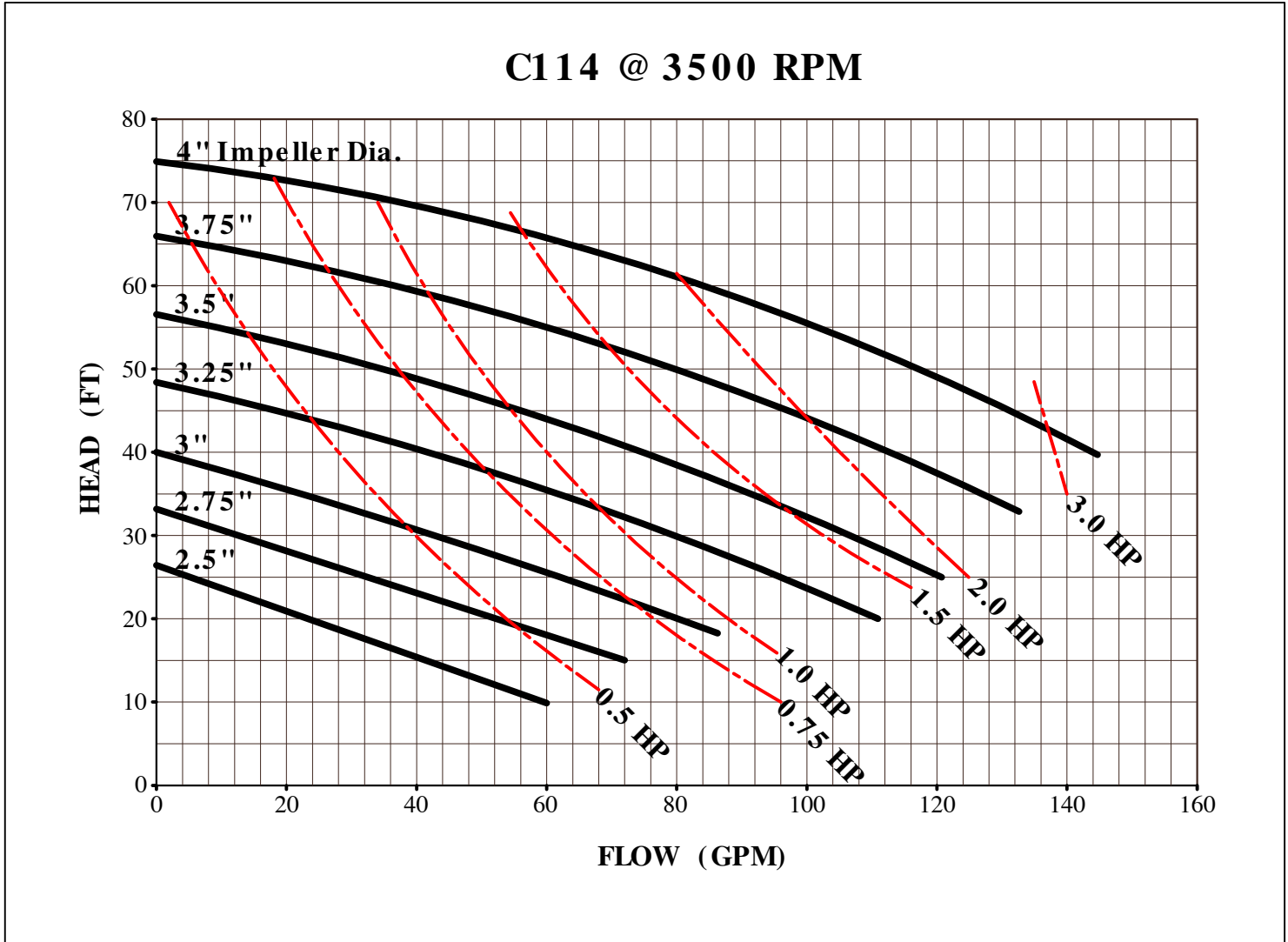

C Series Centrifugal Pump

Size: 2x1.5x4
RPM: 1750
Frequency: 60 Hz
Model #: C214

PERFORMANCE CURVES (Based on H₂O @ 70° F)

C214 @ 1750 RPM

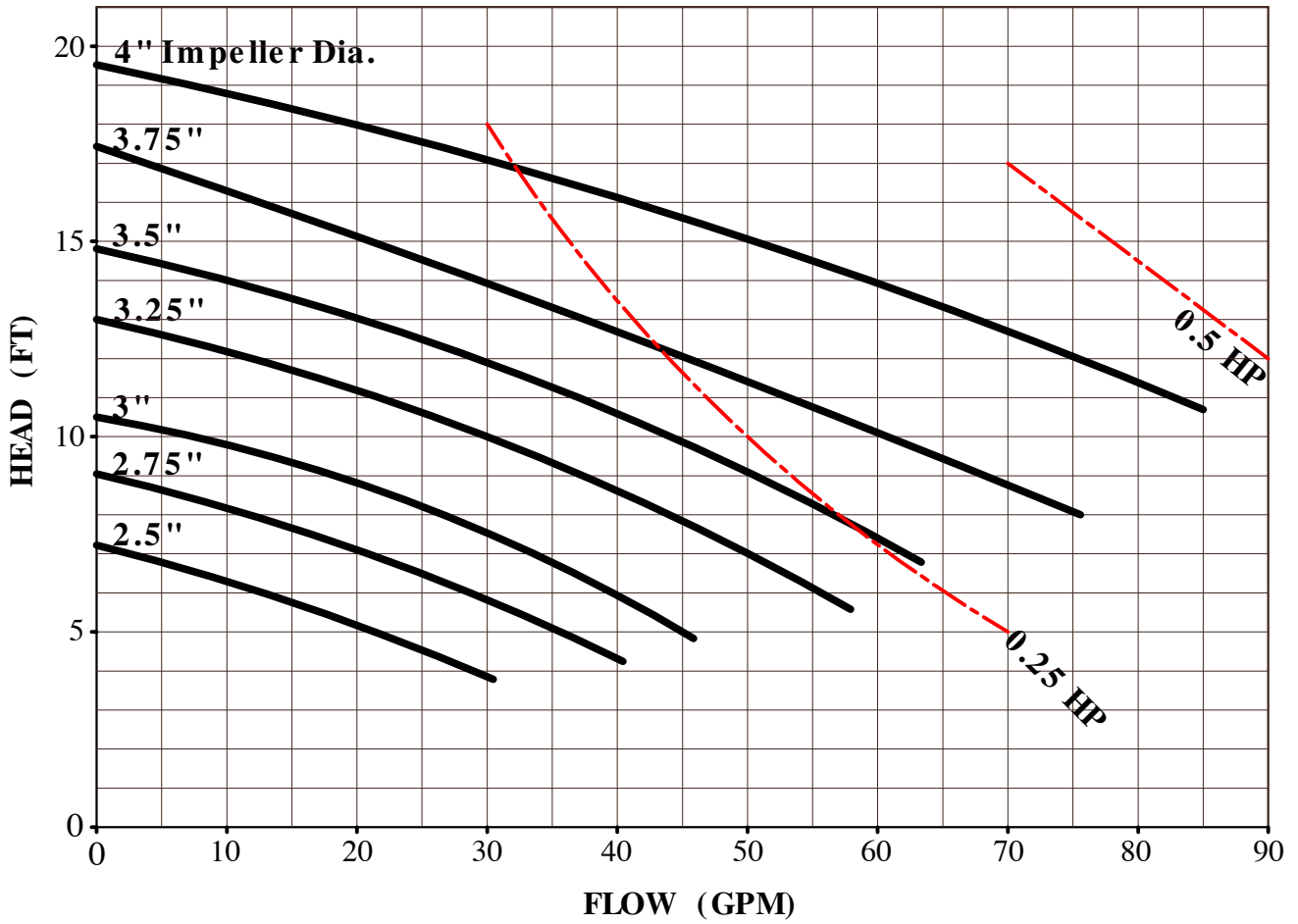

NPSHR (4" Impeller)

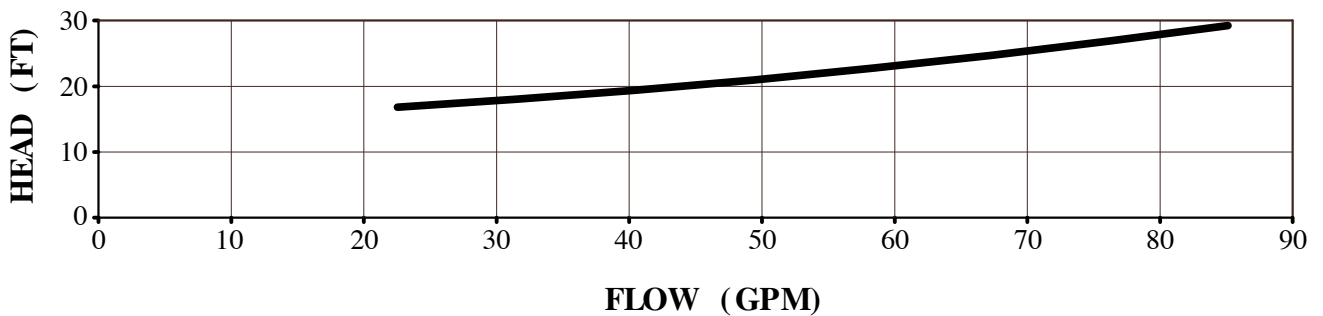

C Series Centrifugal Pump

Size: 2x1.5x4
RPM: 3500
Frequency: 60 Hz
Model #: C214

PERFORMANCE CURVES (Based on H₂O @ 70° F)

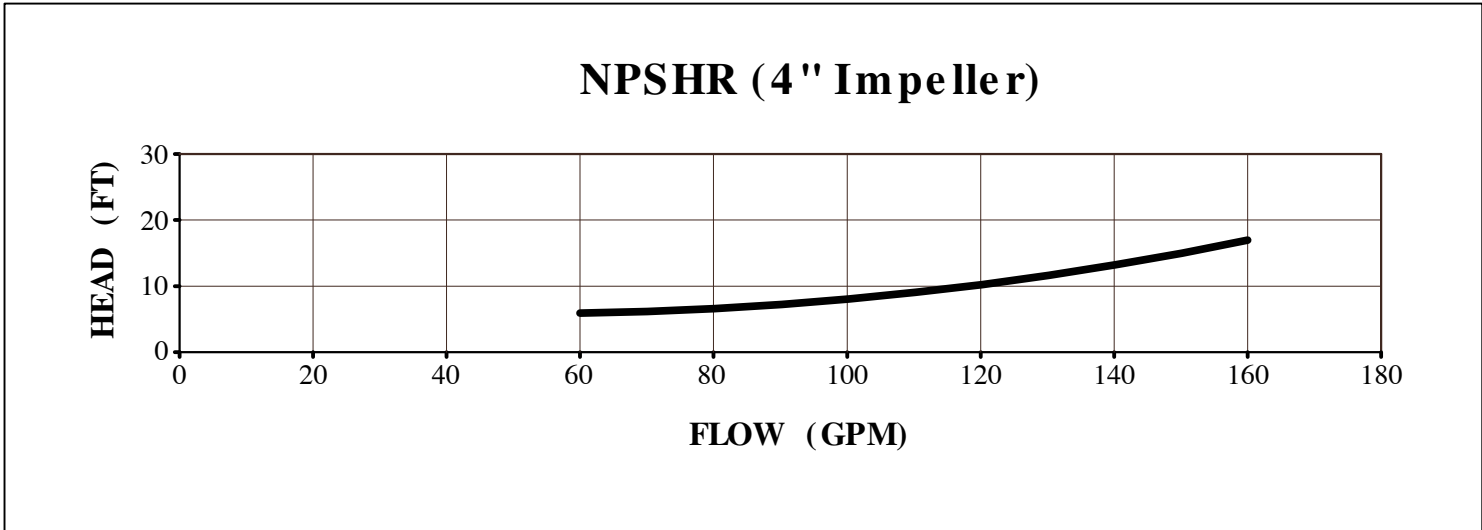
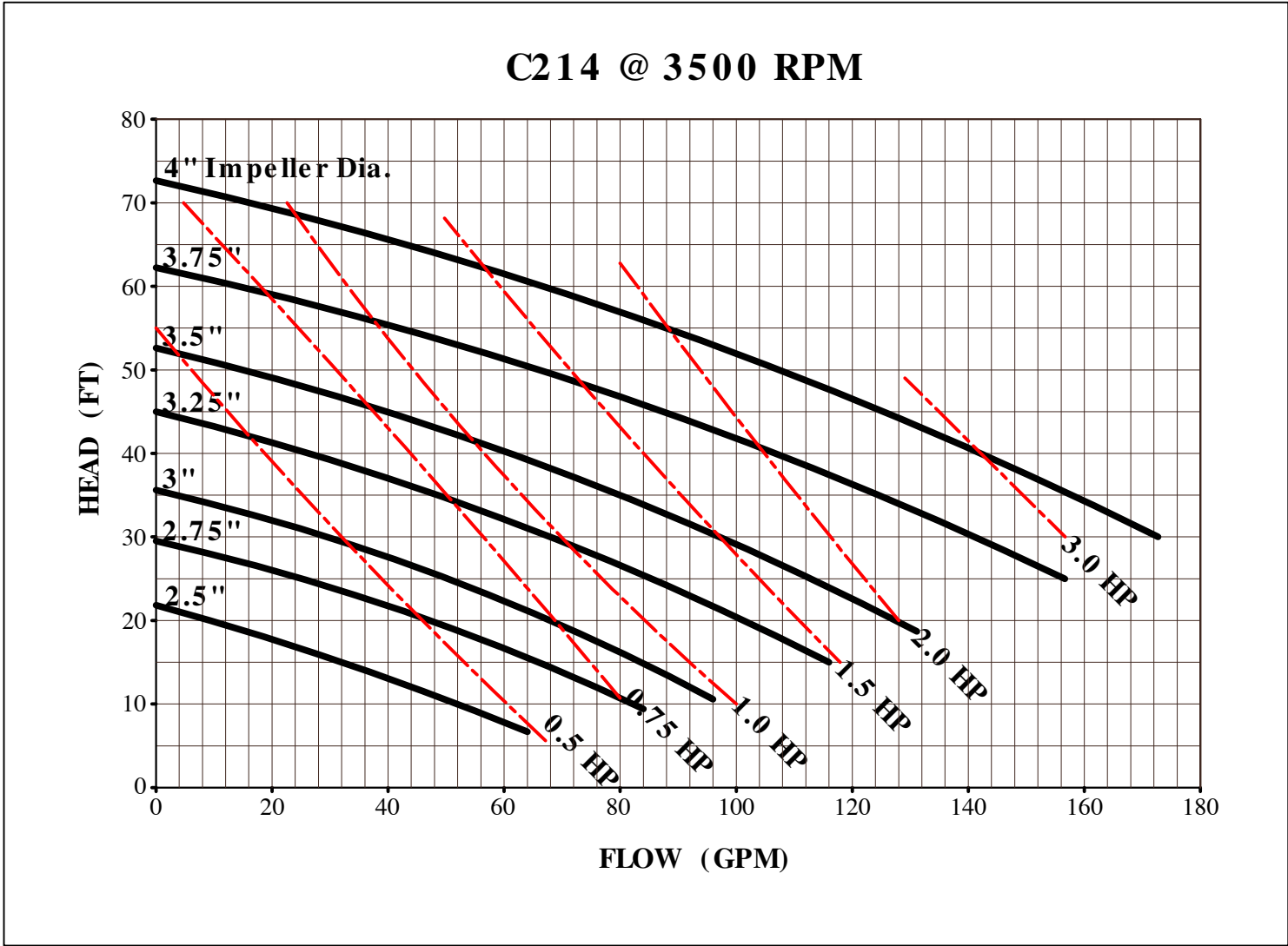

C Series Centrifugal Pump

Size: 2x1.5x6
RPM: 1750
Frequency: 60 Hz
Model #: C216

PERFORMANCE CURVES (Based on H₂O @ 70° F)

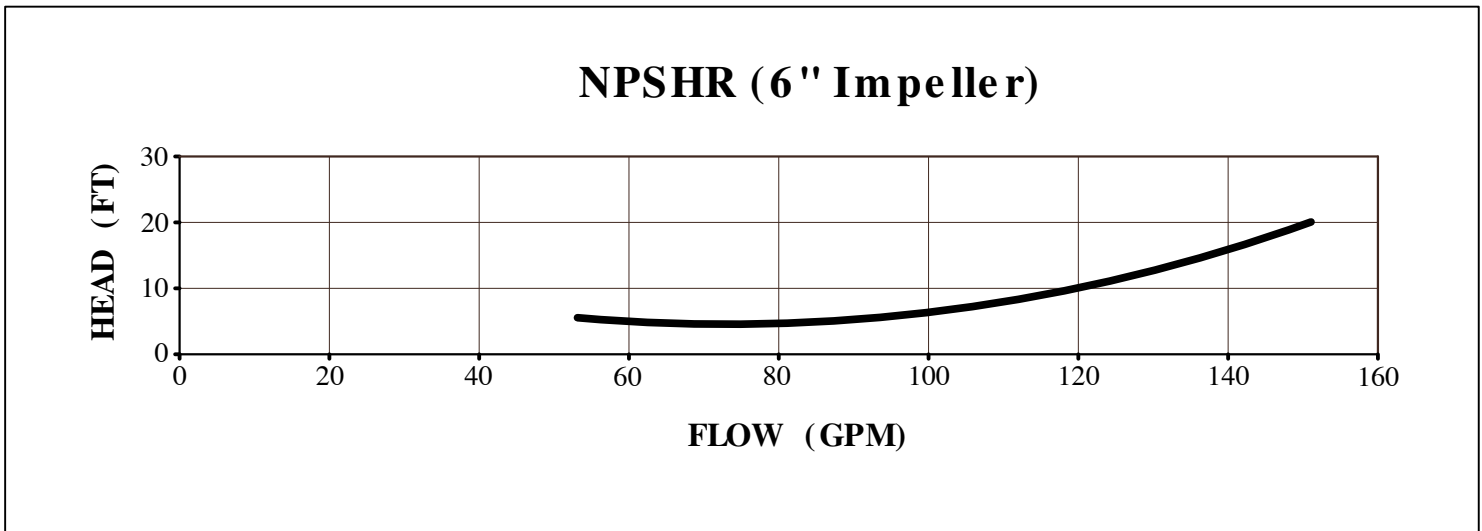
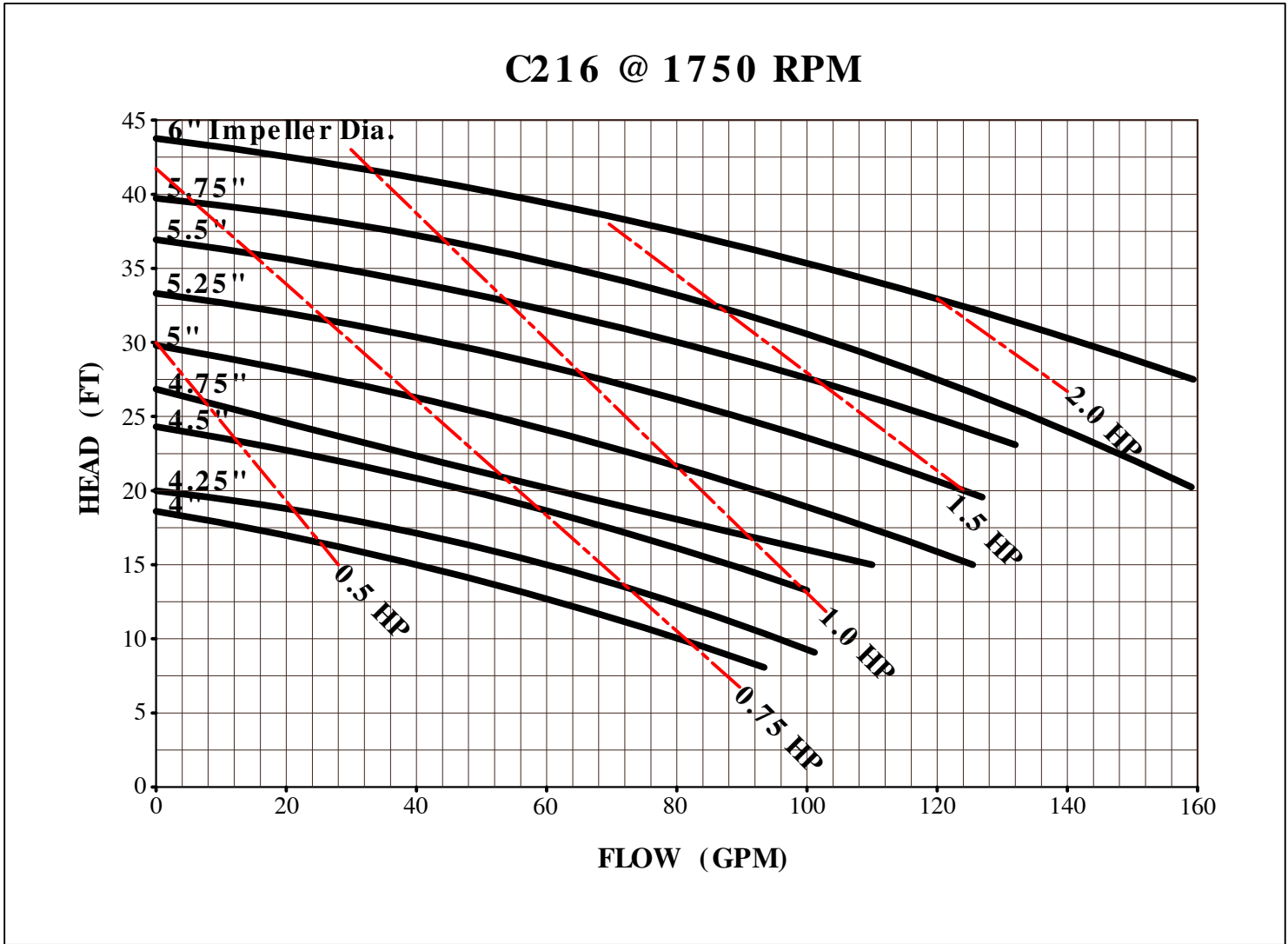

C Series Centrifugal Pump

Size: 2x1.5x6
RPM: 3500
Frequency: 60 Hz
Model #: C216

PERFORMANCE CURVES (Based on H₂O @ 70° F)

C216 @ 3500 RPM

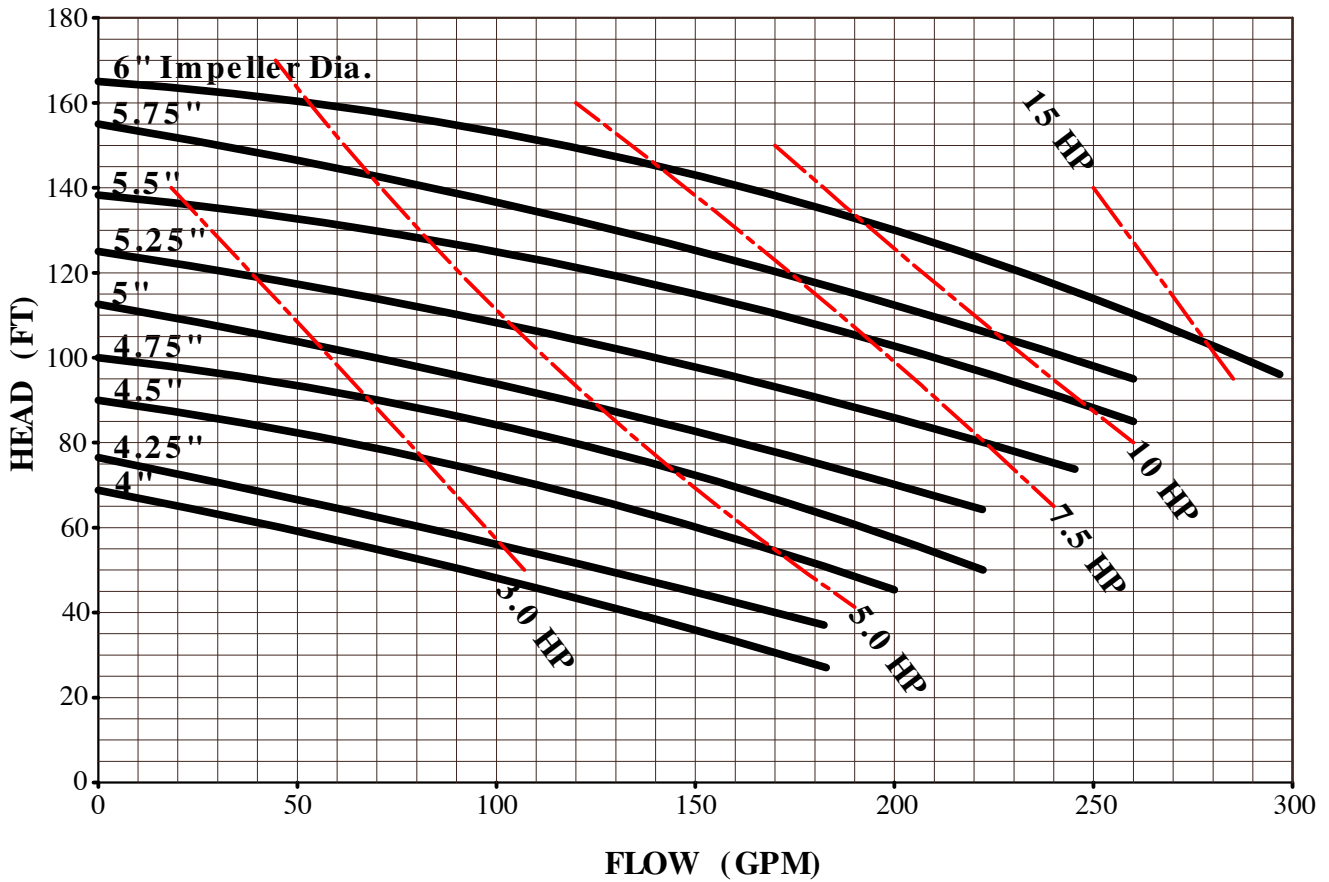

NPSHR (6" Impeller)

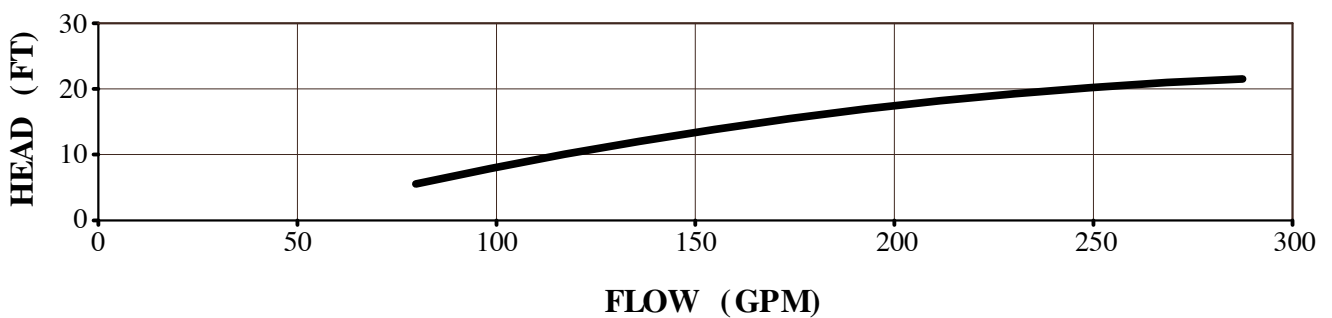

C Series Centrifugal Pump

Size: 2.5x1.5x6
RPM: 1750
Frequency: 60 Hz
Model #: C516

PERFORMANCE CURVES (Based on H₂O @ 70° F)

C516 @ 1750 RPM

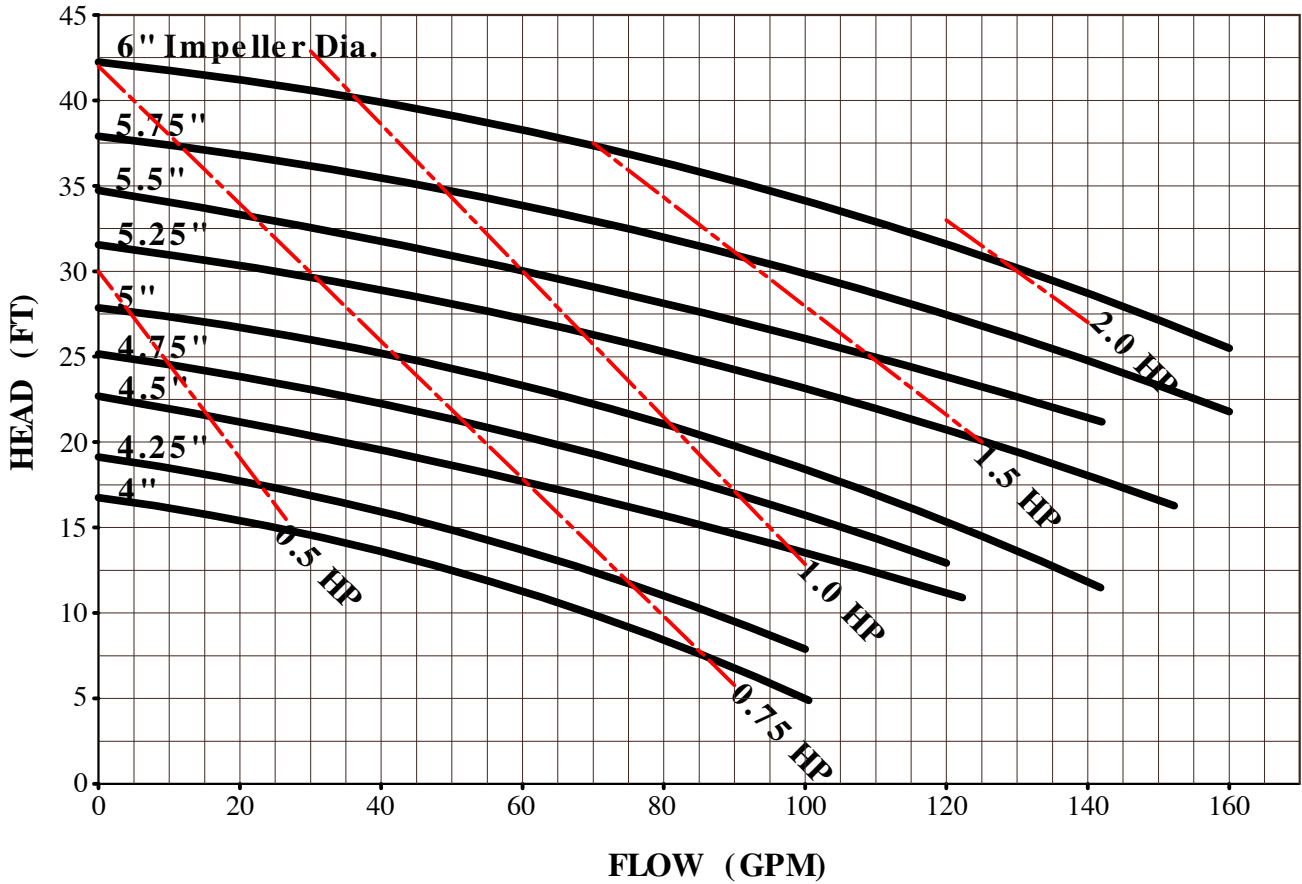

NPSHR (6" Impeller)

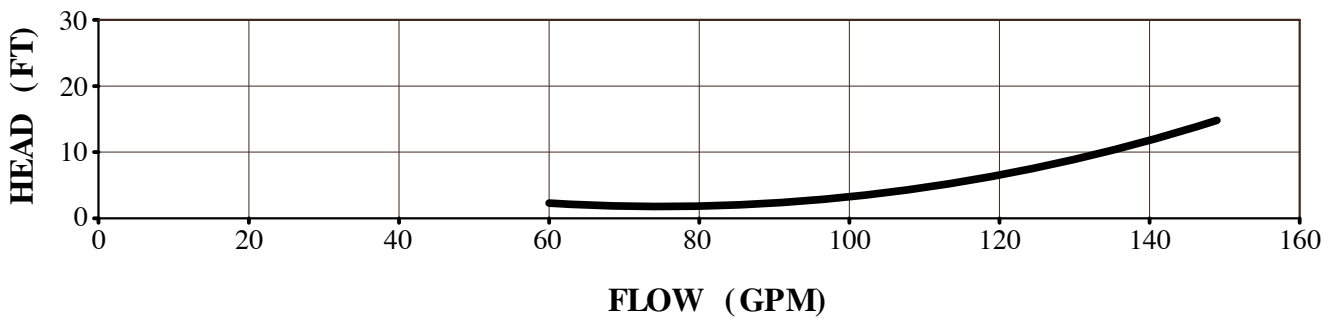

C Series Centrifugal Pump

Size: 2.5x1.5x6
RPM: 3500
Frequency: 60 Hz
Model #: C516

PERFORMANCE CURVES (Based on H₂O @ 70° F)

C516 @ 3500 RPM

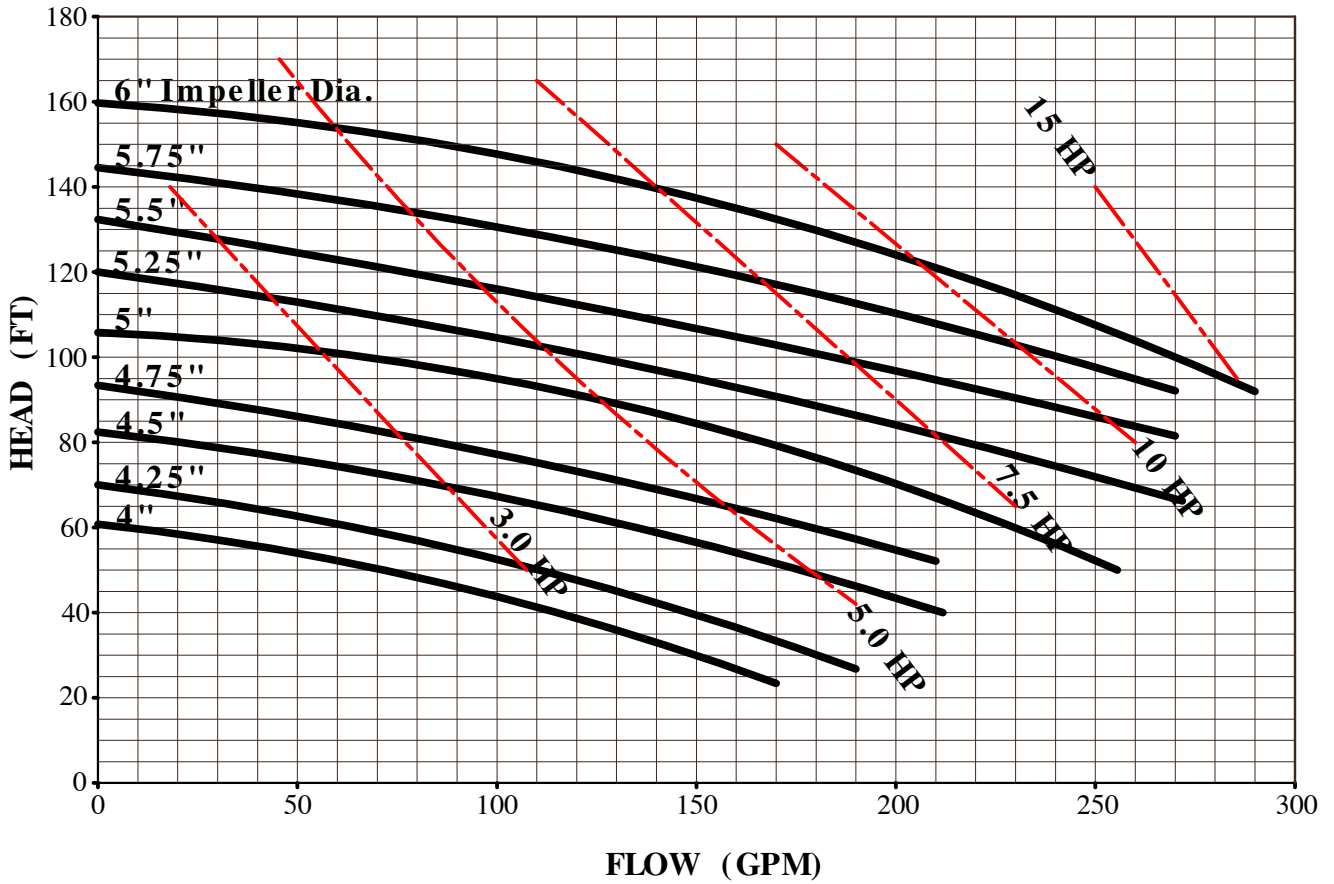

NPSHR (6" Impeller)

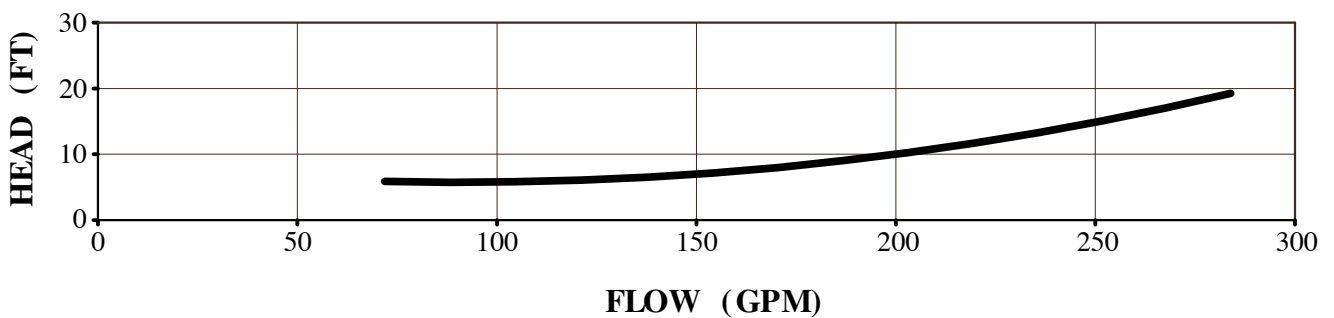

C Series Centrifugal Pump

Size: **2x1.5x8**
RPM: **1750**
Frequency: **60 Hz**
Model #: **C218**

PERFORMANCE CURVES (Based on H₂O @ 70° F)

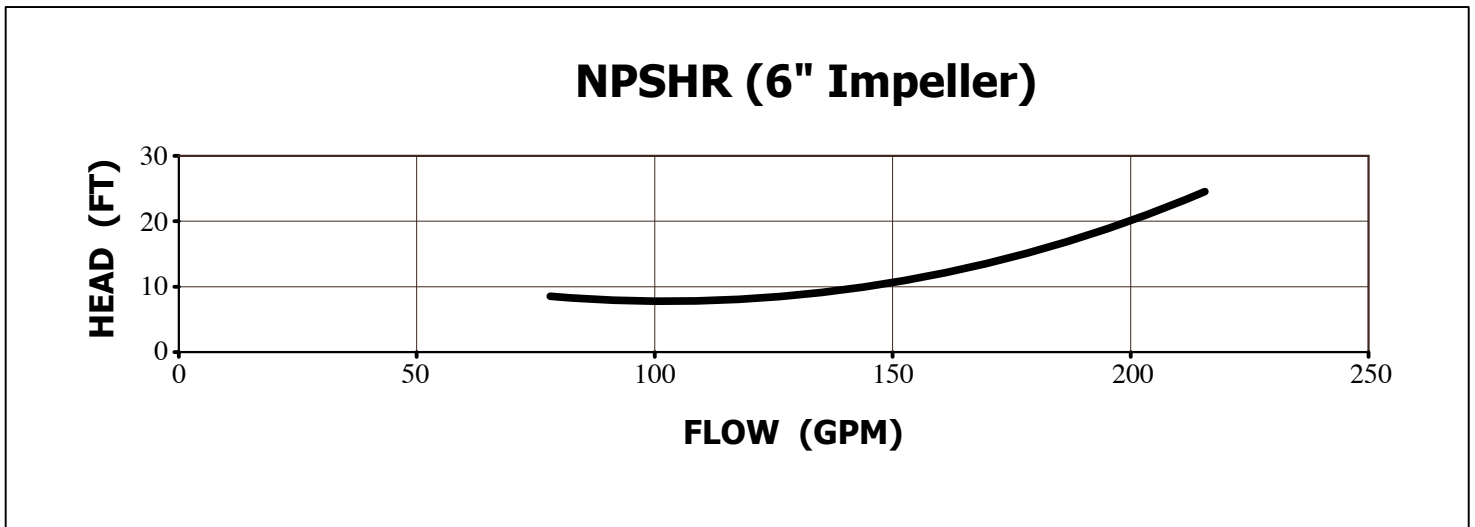
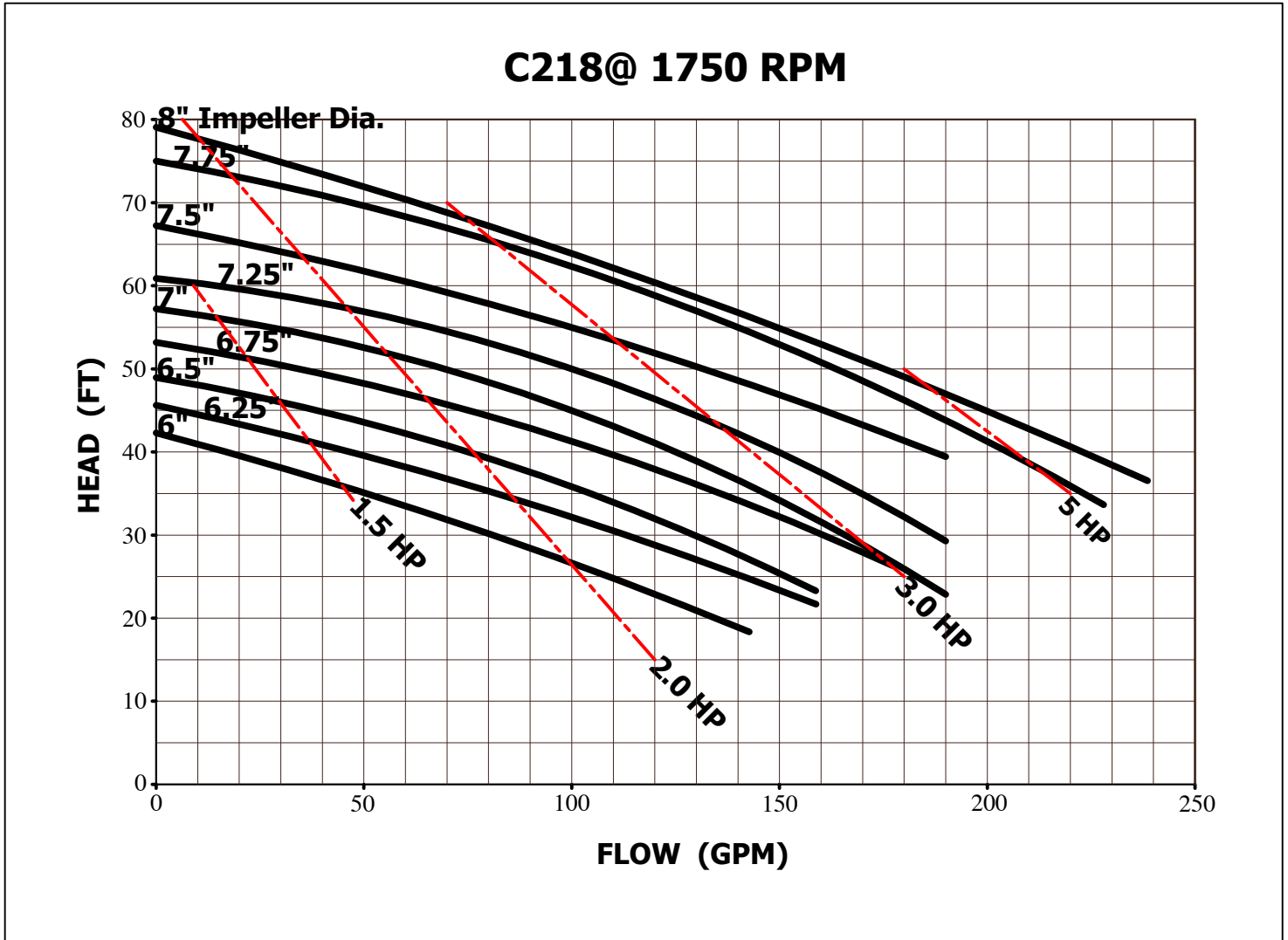

C Series Centrifugal Pump

Size: 2x1.5x8
RPM: 3500
Frequency: 60 Hz
Model #: C218

PERFORMANCE CURVES (Based on H₂O @ 70° F)

C218 @ 3500 RPM

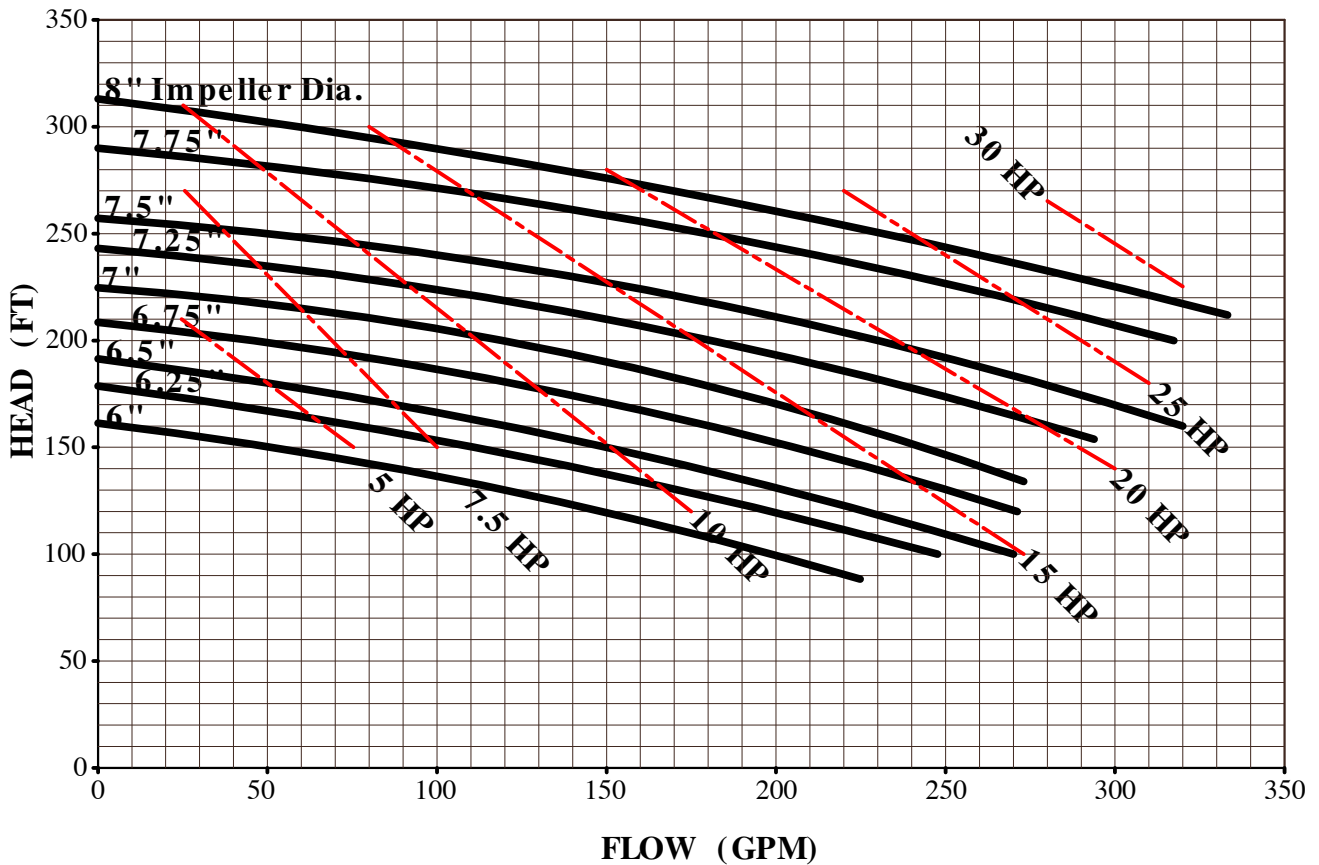

NPSHR (8" Impeller)

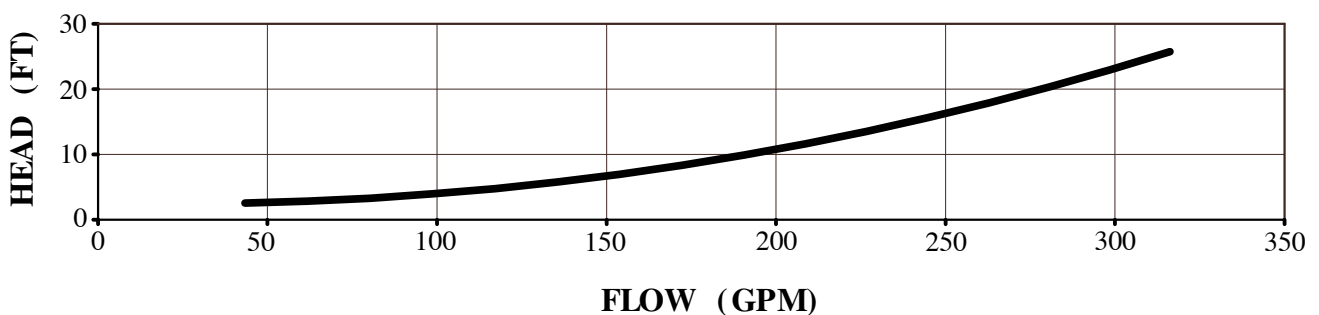

C Series Centrifugal Pump

Size: 3x1.5x8
RPM: 1750
Frequency: 60 Hz
Model #: C318

PERFORMANCE CURVES (Based on H₂O @ 70° F)

C318 @ 1750 RPM

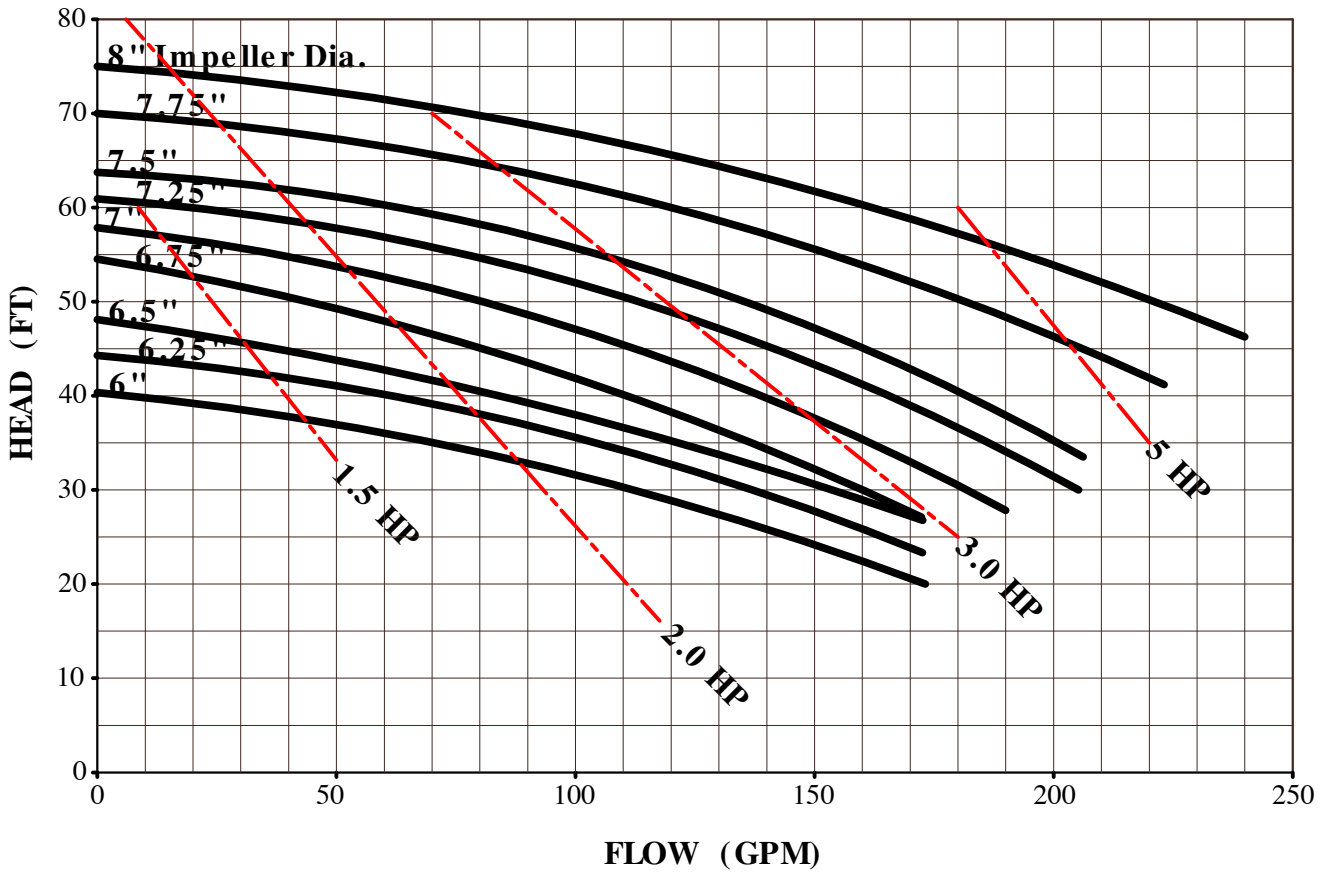

NPSHR (8" Impeller)

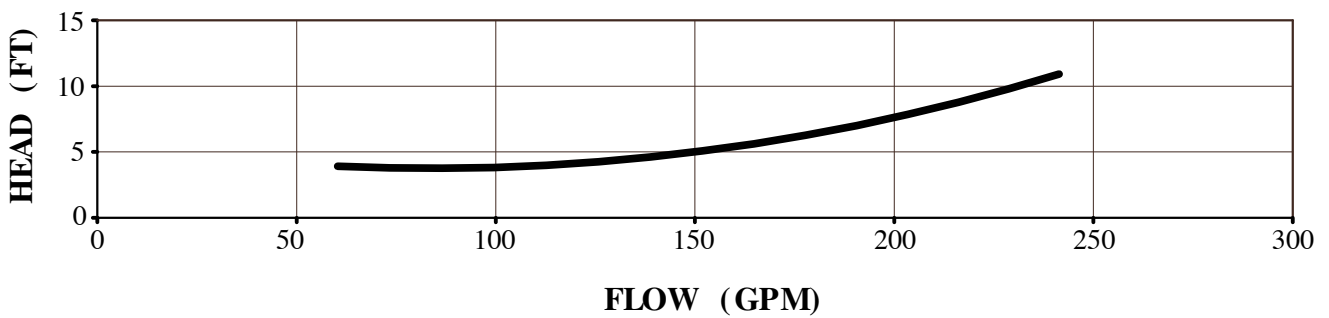

C Series Centrifugal Pump

Size: 3x1.5x8
RPM: 3500
Frequency: 60 Hz
Model #: C318

PERFORMANCE CURVES (Based on H₂O @ 70° F)

C318 @ 3500 RPM

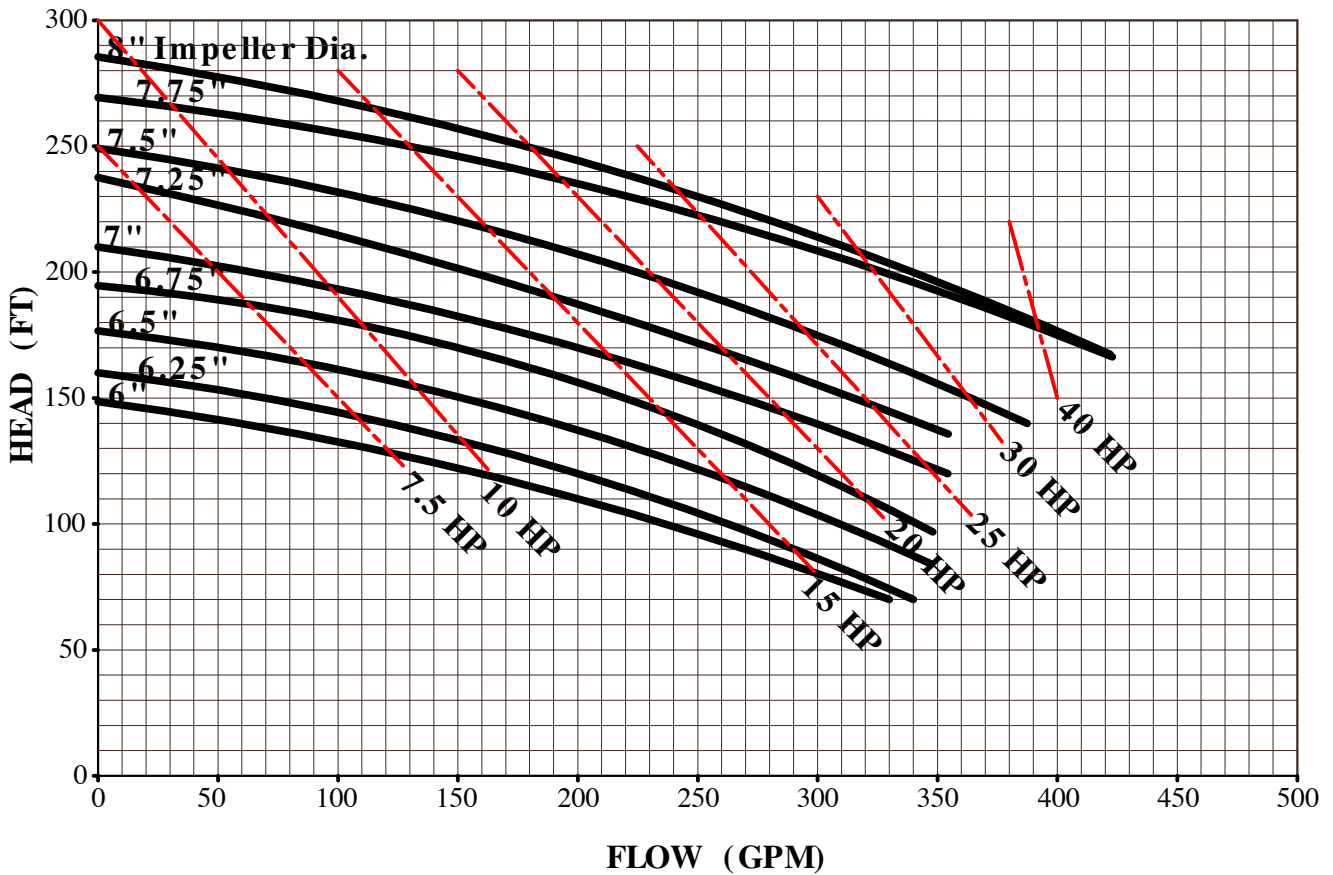

NPSHR (8" Impeller)

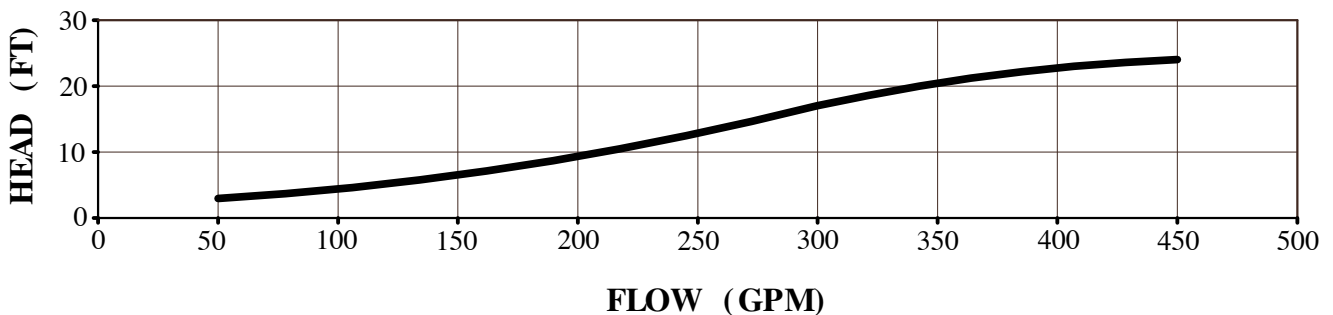

C Series Centrifugal Pump

Size: 3x2x8
RPM: 1750
Frequency: 60 Hz
Model #: C328

PERFORMANCE CURVES (Based on H₂O @ 70° F)

C328 @ 1750 RPM

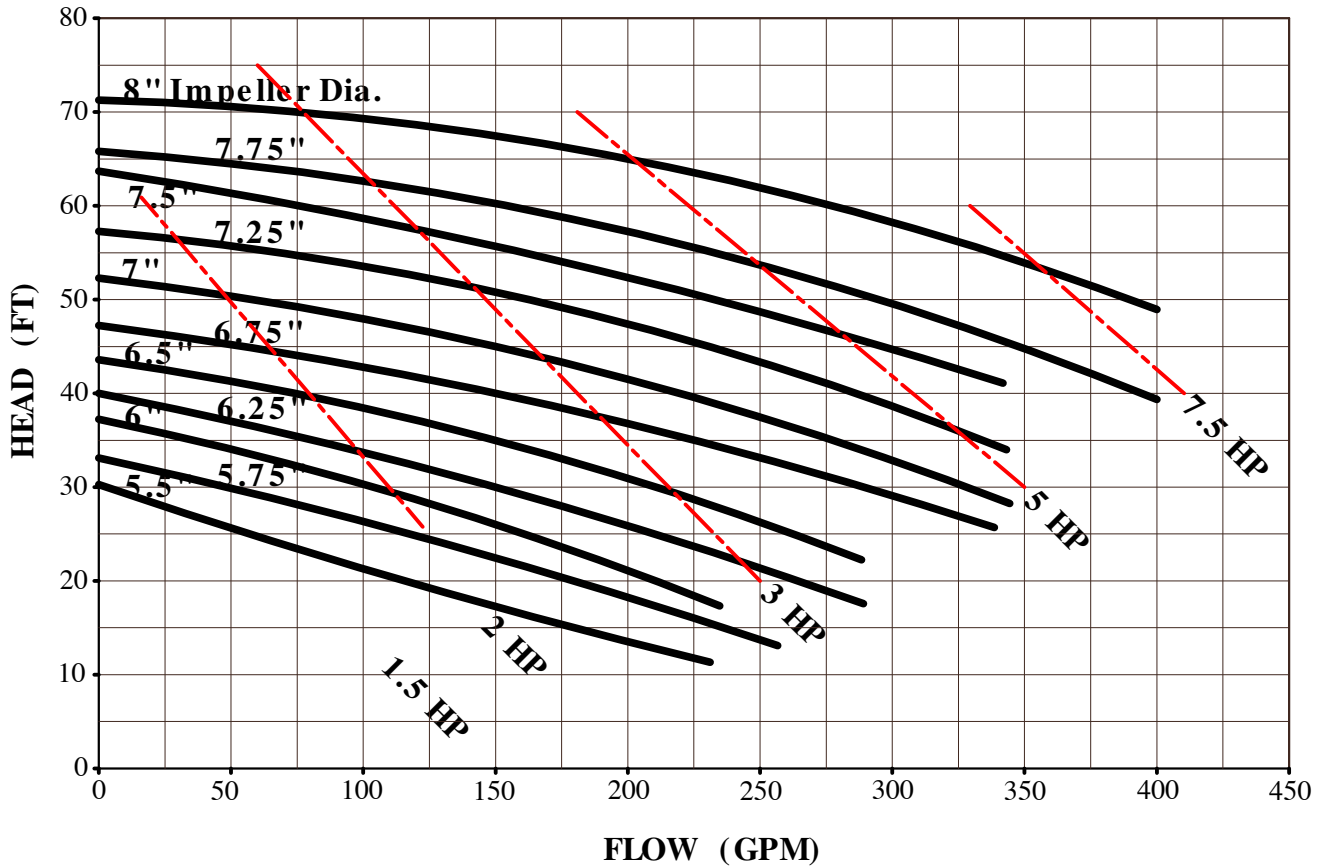

NPSHR (8" Impeller)

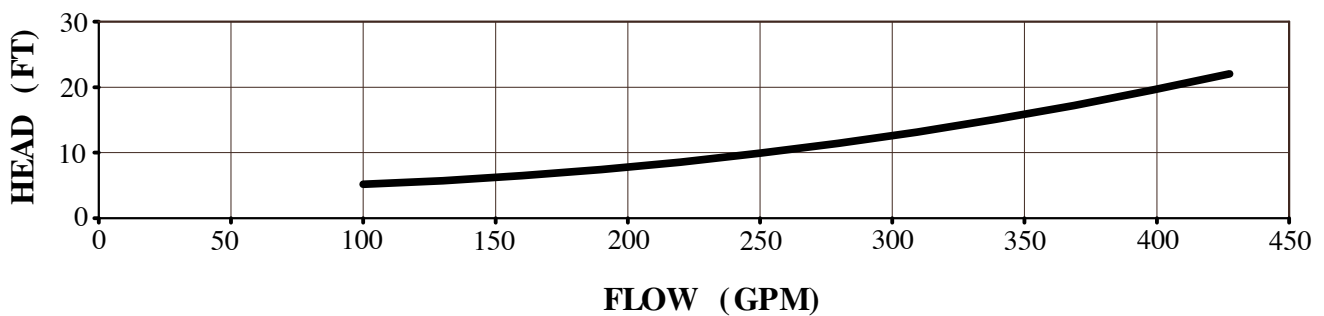

C Series Centrifugal Pump

Size: 3x2x8
RPM: 3500
Frequency: 60 Hz
Model #: C328

PERFORMANCE CURVES (Based on H₂O @ 70° F)

C328 @ 3500 RPM

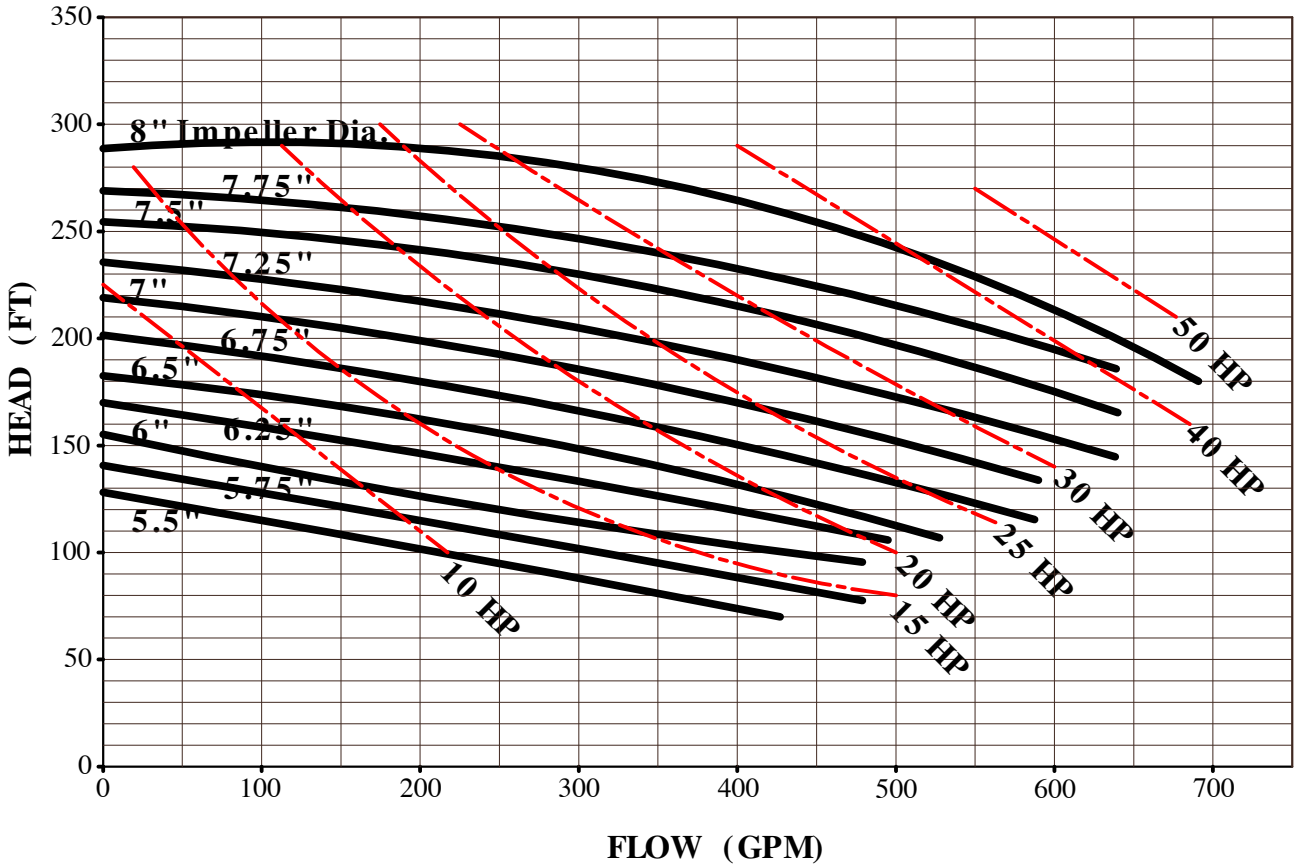

NPSHR (8" Impeller)

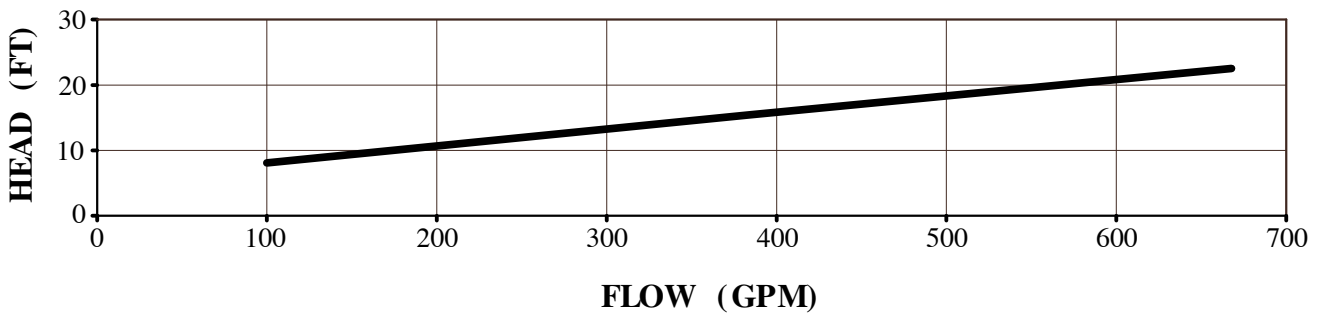

C Series Centrifugal Pump

Size: 4x2x8
RPM: 1750
Frequency: 60 Hz
Model #: C428

PERFORMANCE CURVES (Based on H₂O @ 70° F)

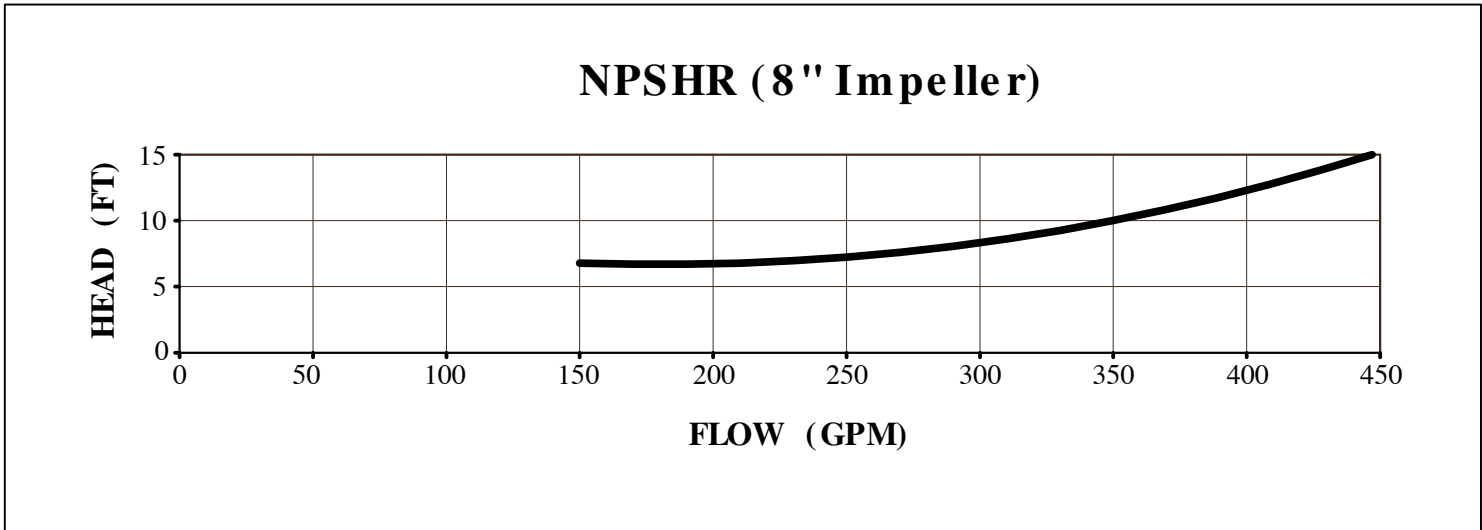
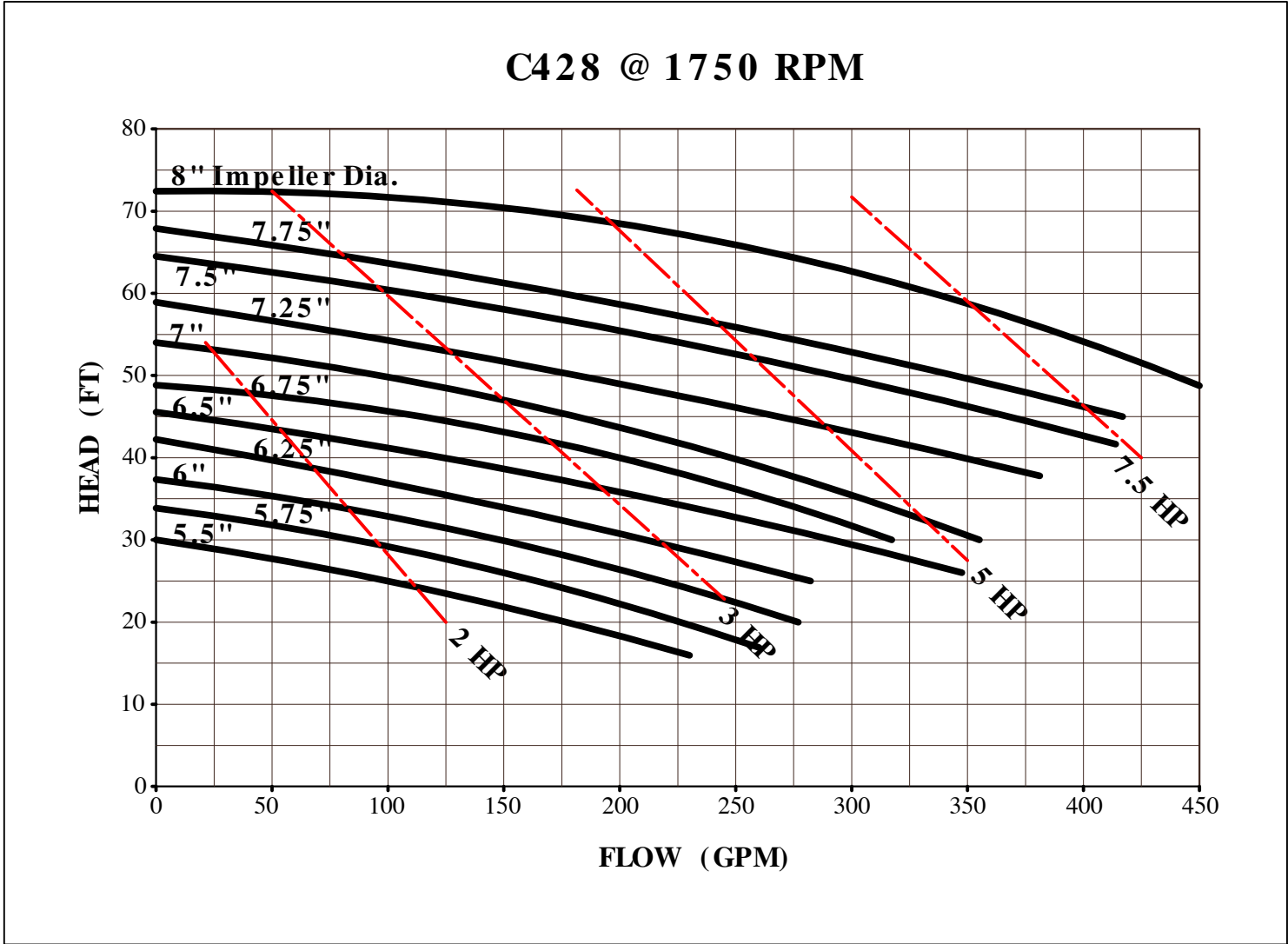

C Series Centrifugal Pump

Size: 4x2x8
RPM: 3500
Frequency: 60 Hz
Model #: C428

PERFORMANCE CURVES (Based on H₂O @ 70° F)

